

NEON-FLEX 0817

9.6W/m

*Buy from expert of
Linear Lighting*

Powered by OSRAM LED

FEATURES

- ❖ High Quality Bin Chip Selection
- ❖ Dot-free linear illumination
- ❖ Fabricated with Eco-friendly, UV-resistant silicone material
- ❖ SMD LED technology
- ❖ Low voltage, safe and reliable
- ❖ High quality at a lifetime of >30000 hrs

COLORS AVAILABLE

2200K / 2700K / 3000K / 3500K /
4000K / 5000K / 6500K / 10000K/



APPLICATIONS

- ❖ Hospitality
- ❖ Architectural
- ❖ Retail
- ❖ Commercial
- ❖ Residence
- ❖ Decorative
- ❖ General Lighting and Signage

PROFILE



Also
Available with
Aluminum Profil
NEON FLEX 0817



TECHNICAL DETAILS

Product no.	Color	Nominal Voltage	LED quantity	Rated wattage	Color rendering	Luminous flux	Luminous efficacy
NF0817-120-24-22	2200K	24V DC	120 LED/m	9.6 W/m	Ra80+		
NF0817-120-24-27	2700K	24V DC	120 LED/m	9.6 W/m	Ra80+		
NF0817-120-24-30	3000K	24V DC	120 LED/m	9.6 W/m	Ra80+		
NF0817-120-24-35	3500K	24V DC	120 LED/m	9.6 W/m	Ra80+		
NF0817-120-24-40	4000K	24V DC	120 LED/m	9.6 W/m	Ra80+		
NF0817-120-24-50	5000K	24V DC	120 LED/m	9.6 W/m	Ra80+		
NF0817-120-24-57	5700K	24V DC	120 LED/m	9.6 W/m	Ra80+		
NF0817-120-24-65	6500K	24V DC	120 LED/m	9.6 W/m	Ra80+		
NF0817-120-24-10	10000K	24V DC	120 LED/m	9.6 W/m	Ra80+		
NF0817-120-24-A	AMBER	24V DC	120 LED/m	9.6 W/m	Ra80+		
NF0817-120-24-R	RED	24V DC	120 LED/m	9.6 W/m	Ra80+		
NF0817-120-24-G	GREEN	24V DC	120 LED/m	9.6 W/m	Ra80+		
NF0817-120-24-B	BLUE	24V DC	120 LED/m	9.6 W/m	Ra80+		
NF0817-120-24-P	P INK	24V DC	120 LED/m	9.6 W/m	Ra80+		
NF0817-120-24-IC	ICE BLUE	24V DC	120 LED/m	9.6 W/m	Ra80+		
NF0817-120-24-O	ORANGE	24V DC	120 LED/m	9.6 W/m	Ra80+		
NF0817-120-24-F	FLAME	24V DC	120 LED/m	9.6 W/m	Ra80+		
NF0817-120-24-Y	YELLOW	24V DC	120 LED/m	9.6 W/m	Ra80+		

SPECIFICATIONS

Type of LED	Cuttable Length	Width (mm)	Height (mm)	Maximum length (m)	Beam Angle	Tc max	Ingress Protection	Material
2835	50 mm	8.5 mm	17.5 mm	5 m/reel	120°	< 75°C	IP 65	Silicone

(* Conditions Apply)

2 Year Warranty *

Standard Configuration **

DIMENSIONS

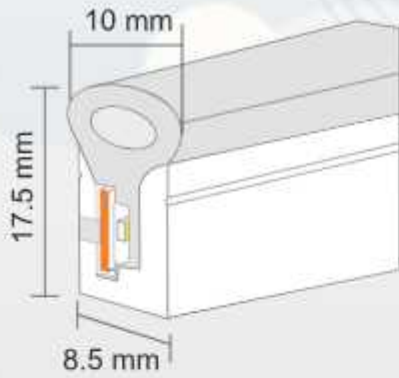

CROSS SECTION



CUTTING MARK



ACCESSORIES



End cap with hole

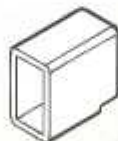

End cap no hole



Aluminum Clip



Glue

MOUNTING

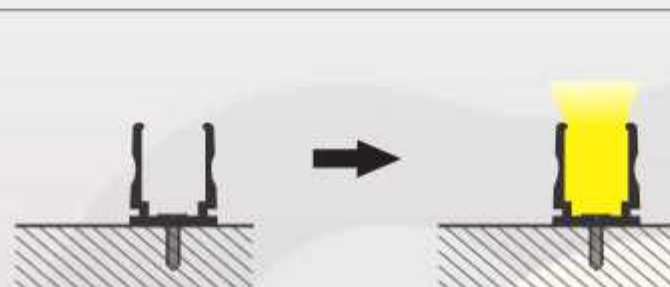

Installation Diagram

PHOTOMETRIC DRAWING

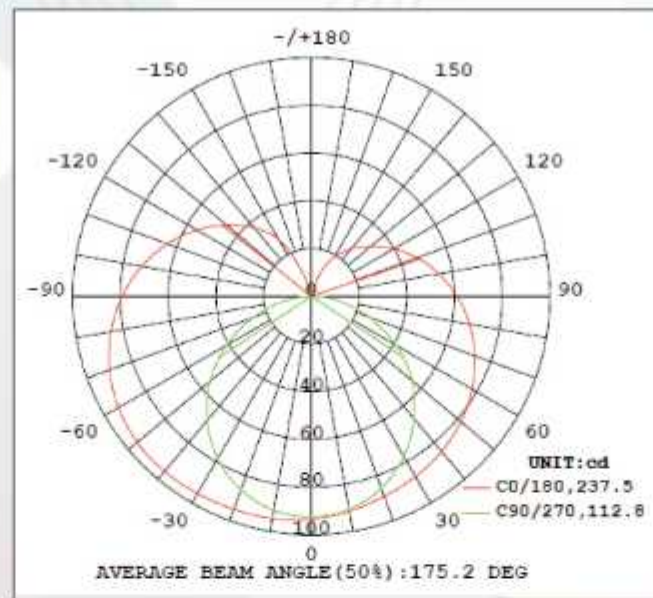

PRECAUTIONS

- 1.] All installation and connection must be conducted by professional electrician.
- 2.] 24VDC Class 2 Power Supply must be used with this light. Make sure to use appropriate PSU.
- 3.] Ensure the overall length of the Style NeonFlex does not exceed the maximum run length as 15m-one end powered; 30m- two ends powered.
- 4.] Disconnect power before installing or servicing to avoid electrical shock.
- 5.] For wet location installations, seal all possible water entry points and covers using by silicone. Failure to do so may result in product defective.

WARNING !

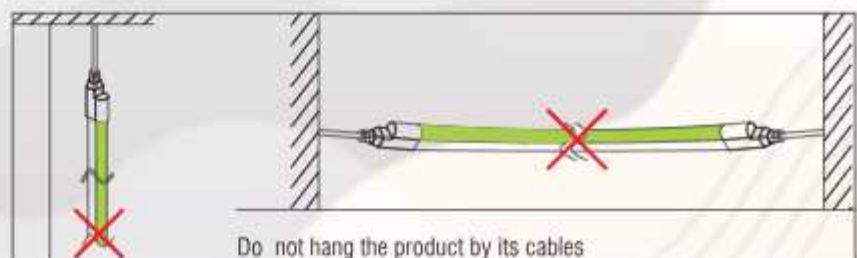
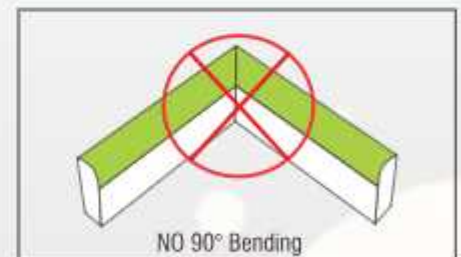
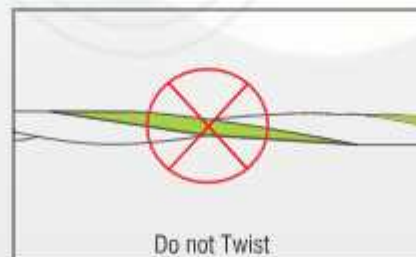
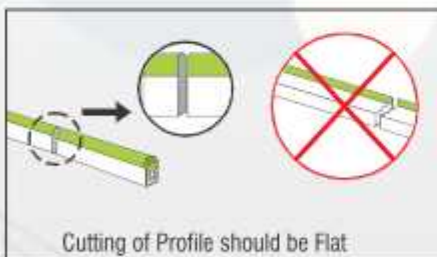

> All product names, trademarks and registered trademarks are property of their respective owners.

PACKAGING



Roll the NeonFlex on a Reel



Insert the Reel in the Polybag & Label it



Insert the Polybag in the Master Carton



Seal & Label the Master Carton

Product no.	Net Weight (gm)	Gross Weight (gm)	Carton Size (mm)	Packaging Unit (mm)
NEON FLEX	0.67 gm	0.88 gm	255x165x190 mm	Shipping Carton Box 20 nos

DISCLAIMER :-

Subject to change without notice. Errors and omission excepted. Always make sure to use updated version. All product names, trademarks and registered trademarks are property of their respective owners.

Brilliant colour rendering: the new LED strip NeonFlex 0817



Manufactured and Distributed by



+91 83800 10000 / +91 98202 36828 / +91 98202 87187

Info@digiopto.com, projects@digiopto.com digiopto.com

Unit no 201, Anila Shanti Industrial Est, Bldg no 2, Dhumal Nagar, Waliv, Vasai (East), Dist. Palghar - Pin- 401208. INDIA.

Linear Lighting Solutions by

DigiLED

